

LP395

Ultra Reliable Power Transistor

General Description

The LP395 is a fast monolithic transistor with complete overload protection. This very high gain transistor has included on the chip, current limiting, power limiting, and thermal overload protection, making it difficult to destroy from almost any type of overload. Available in an epoxy TO-92 transistor package this device is guaranteed to deliver 100 mA.

Thermal limiting at the chip level, a feature not available in discrete designs, provides comprehensive protection against overload. Excessive power dissipation or inadequate heat sinking causes the thermal limiting circuitry to turn off the device preventing excessive die temperature.

The LP395 offers a significant increase in reliability while simplifying protection circuitry. It is especially attractive as a small incandescent lamp or solenoid driver because of its low drive requirements and blowout-proof design.

The LP395 is easy to use and only a few precautions need be observed. Excessive collector to emitter voltage can destroy the LP395 as with any transistor. When the device is used as an emitter follower with a low source impedance, it is necessary to insert a 4.7 kΩ resistor in series with the base lead to prevent possible emitter follower oscillations. Also since it has good high frequency response, supply by-passing is recommended.

Areas where the LP395 differs from a standard NPN transistor are in saturation voltage, leakage (quiescent) current and

in base current. Since the internal protection circuitry requires voltage and current to function, the minimum voltage across the device in the on condition (saturated) is typically 1.6 Volts, while in the off condition the quiescent (leakage) current is typically 200 μA. Base current in this device flows out of the base lead, rather than into the base as is the case with conventional NPN transistors. Also the base can be driven positive up to 36 Volts without damage, but will draw current if driven negative more than 0.6 Volts. Additionally, if the base lead is left open, the LP395 will turn on.

The LP395 is a low-power version of the 1-Amp LM195/LM295/LM395 Ultra Reliable Power Transistor.

The LP395 is rated for operation over a -40°C to +125°C range.

Features

- Internal thermal limiting
- Internal current and power limiting
- Guaranteed 100 mA output current
- 0.5 μA typical base current
- Directly interfaces with TTL or CMOS
- +36 Volts on base causes no damage
- 2 μs switching time

Connection Diagram

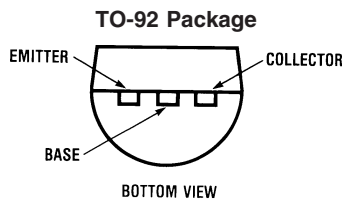

00552501

Order Number LP395Z
See NS Package Z03A

Typical Applications

Fully Protected Lamp Driver

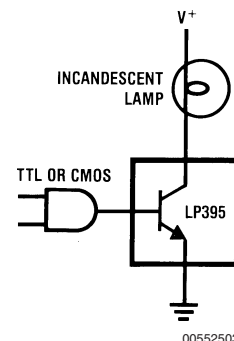

Absolute Maximum Ratings (Note 1)

Collector to Emitter Voltage	36V
Collector to Base Voltage	36V
Base to Emitter Voltage (Forward)	36V
Base to Emitter Voltage (Reverse)	10V
Base to Emitter Current (Reverse)	20 mA

Collector Current Limit	Internally Limited
Power Dissipation	Internally Limited
Operating Temperature Range	-40°C to +125°C
Storage Temperature Range	-65°C to +150°C
Lead Temp. (Soldering, 10 seconds)	260°C

Electrical Characteristics

Symbol	Parameter	Conditions	Typical	Tested Limit (Note 3)	Design Limit (Note 4)	Units (Limit)
V_{CE}	Collector to Emitter Operating Voltage	$0.5 \text{ mA} \leq I_C \leq 100 \text{ mA}$		36	36 (Note 2)	V(Max)
I_{CL}	Collector Current Limit (Note 5)	$V_{BE} = 2V, V_{CE} = 36V$ $V_{BE} = 2V, V_{CE} = 15V$ $V_{BE} = 2V, 2V \leq V_{CE} \leq 6V$	45 90 130	25 60 100	20 50 100	mA(Min) mA(Min) mA(Min)
I_B	Base Current	$0 \leq I_C \leq 100 \text{ mA}$	-0.3	-2.0	-2.5	$\mu\text{A}(\text{Max})$
I_Q	Quiescent Current	$V_{BE} = 0V, 0 \leq V_{CE} \leq 36V$	0.24	0.50	0.60	mA(Max)
$V_{CE(SAT)}$	Saturation Voltage	$V_{BE} = 2V, I_C = 100 \text{ mA}$	1.82	2.00	2.10	V(Max)
BV_{BE}	Base to Emitter Break-down Voltage (Note 5)	$0 \leq V_{CE} \leq 36V, I_B = 2 \mu\text{A}$		36	36	V(Min)
V_{BE}	Base to Emitter Voltage (Note 6)	$I_C = 5 \text{ mA}$	0.69	0.79	0.90	V(Max)
		$I_C = 100 \text{ mA}$ (Note 5)	1.02		1.40	V (Max)
t_S	Switching Time	$V_{CE} = 20V, R_L = 200\Omega$ $V_{BE} = 0V, +2V, 0V$	2			μs
θ_{JA}	Thermal Resistance Junction to Ambient	0.4" leads soldered to printed circuit board	150		180	$^{\circ}\text{C}/\text{W}$ (Max)
		0.125" leads soldered to printed circuit board	130		160	$^{\circ}\text{C}/\text{W}$ (Max)

Note 1: Absolute Maximum Ratings indicate limits beyond which damage to the device may occur. Operating Ratings indicate conditions for which the device is functional, but do not guarantee specific performance limits.

Note 2: Parameters identified with **boldface type** apply at temp. extremes. All other numbers, unless noted apply at +25°C.

Note 3: Guaranteed and 100% production tested.

Note 4: Guaranteed (but not 100% production tested) over the operating temperature and supply voltage ranges. These limits are not used to calculate outgoing quality levels.

Note 5: These numbers apply for pulse testing with a low duty cycle.

Note 6: Base positive with respect to emitter.

Simplified Circuit

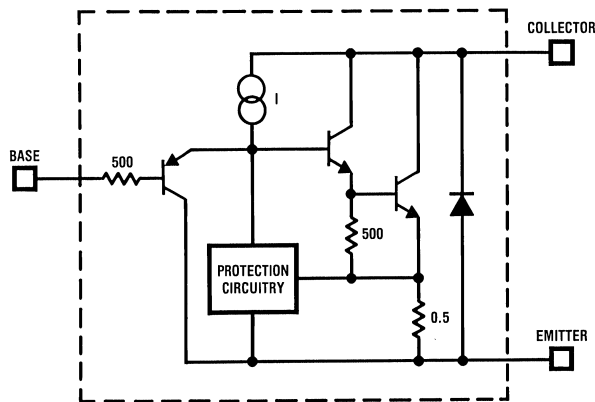

Applications Information

One failure mode incandescent lamps may experience is one in which the filament resistance drops to a very low value before it actually blows out. This is especially rough on most solid-state lamp drivers and in most cases a lamp failure of this type will also cause the lamp driver to fail.

Because of its high gain and blowout-proof design, the LP395 is an ideal candidate for reliably driving small incandescent lamps. Additionally, the current limiting characteristics of the LP395 are advantageous as it serves to limit the cold filament inrush current, thus increasing lamp life.

Typical Performance Characteristics

5 Volt Transfer Function

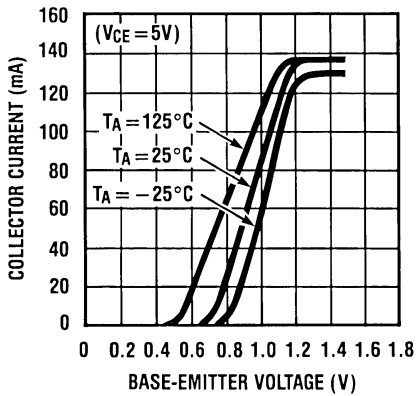

00552510

36 Volt Transfer Function

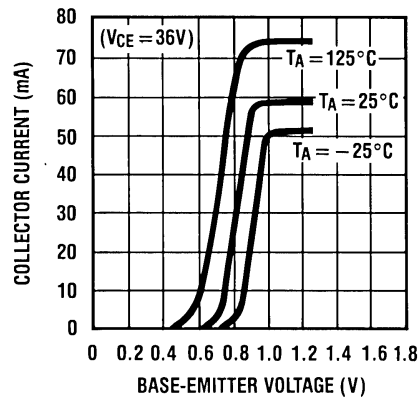

00552511

Collector Characteristics

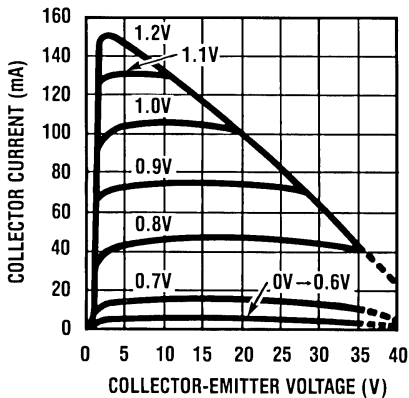

00552512

Available Collector Current

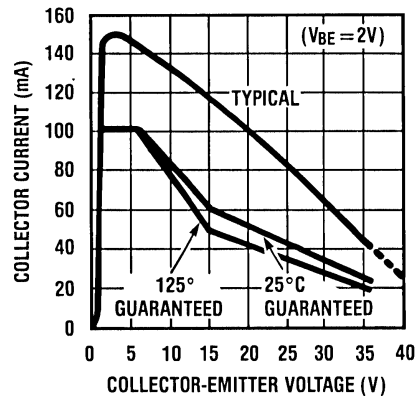

00552513

Quiescent Collector Current

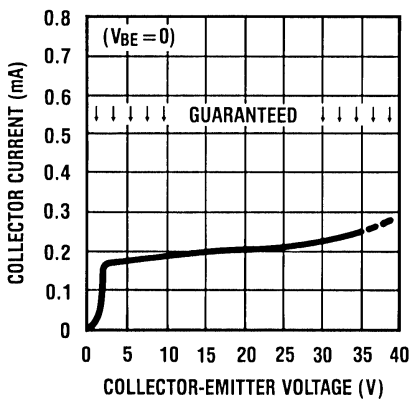

00552514

Saturation Voltage

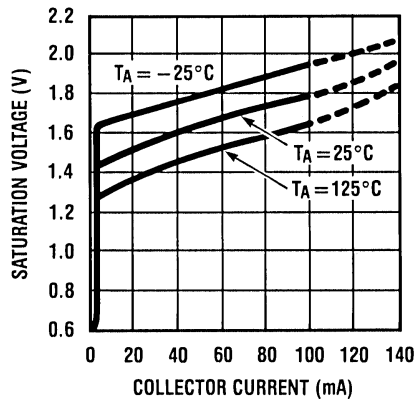

00552515

Typical Performance Characteristics (Continued)

Collector Current Threshold

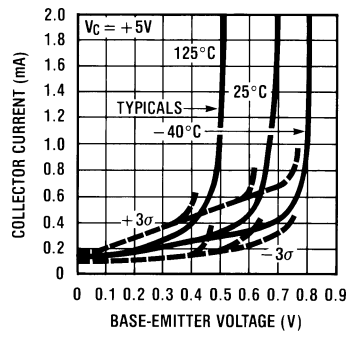

00552509

Typical Applications

**Lamp Flasher
(Short Circuit Proof)**

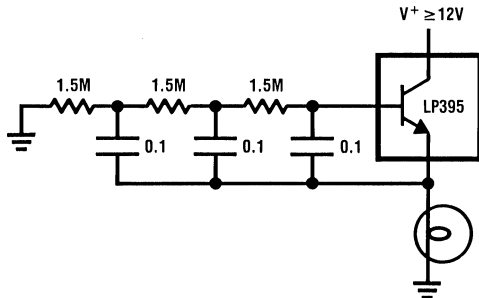

00552506

**Optically Isolated
Switch**

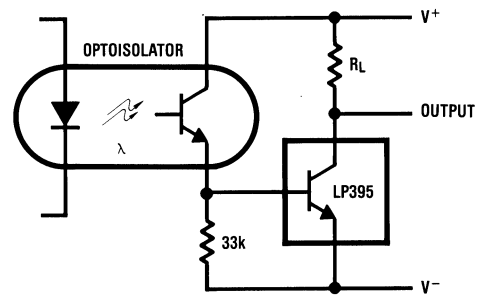

00552507

**Two Terminal
Current Limiter**

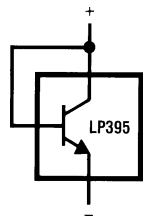

00552508

Composite PNP

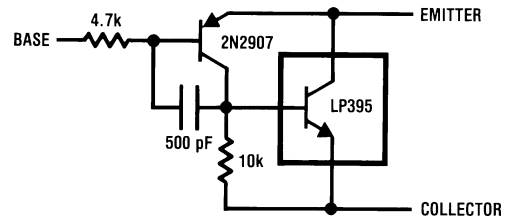

00552502

Physical Dimensions inches (millimeters) unless otherwise noted

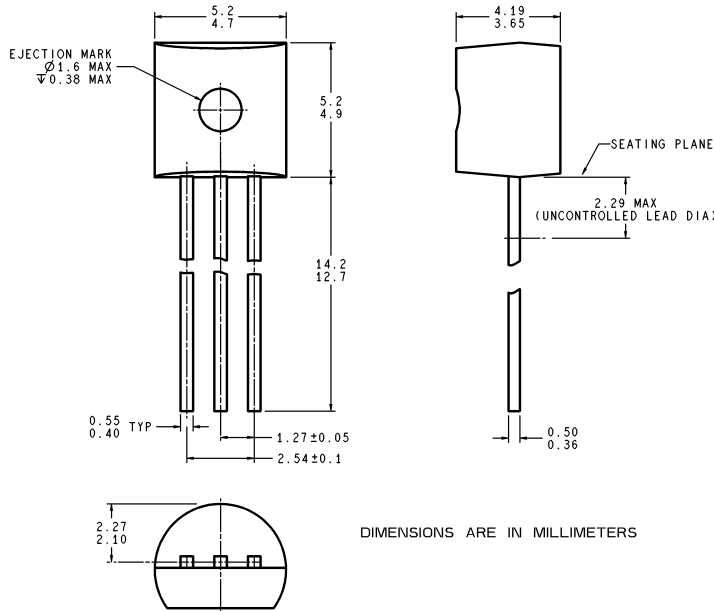

Z03A (Rev G)

**Order Number LP395Z
NS Package Z03A**

National does not assume any responsibility for use of any circuitry described, no circuit patent licenses are implied and National reserves the right at any time without notice to change said circuitry and specifications.

For the most current product information visit us at www.national.com.

LIFE SUPPORT POLICY

NATIONAL'S PRODUCTS ARE NOT AUTHORIZED FOR USE AS CRITICAL COMPONENTS IN LIFE SUPPORT DEVICES OR SYSTEMS WITHOUT THE EXPRESS WRITTEN APPROVAL OF THE PRESIDENT AND GENERAL COUNSEL OF NATIONAL SEMICONDUCTOR CORPORATION. As used herein:

1. Life support devices or systems are devices or systems which, (a) are intended for surgical implant into the body, or (b) support or sustain life, and whose failure to perform when properly used in accordance with instructions for use provided in the labeling, can be reasonably expected to result in a significant injury to the user.
2. A critical component is any component of a life support device or system whose failure to perform can be reasonably expected to cause the failure of the life support device or system, or to affect its safety or effectiveness.

BANNED SUBSTANCE COMPLIANCE

National Semiconductor manufactures products and uses packing materials that meet the provisions of the Customer Products Stewardship Specification (CSP-9-111C2) and the Banned Substances and Materials of Interest Specification (CSP-9-111S2) and contain no "Banned Substances" as defined in CSP-9-111S2.



National Semiconductor
Americas Customer
Support Center
Email: new.feedback@nsc.com
Tel: 1-800-272-9959

National Semiconductor
Europe Customer Support Center
Fax: +49 (0) 180-530 85 86
Email: europa.support@nsc.com
Deutsch Tel: +49 (0) 69 9508 6208
English Tel: +44 (0) 870 24 0 2171
Français Tel: +33 (0) 1 41 91 8790

National Semiconductor
Asia Pacific Customer
Support Center
Email: ap.support@nsc.com

National Semiconductor
Japan Customer Support Center
Fax: 81-3-5639-7507
Email: jpn.feedback@nsc.com
Tel: 81-3-5639-7560